

MAKOL SURGICAL 20



..... **GYNECOLOGY**



Vaginal specula



Standard Vaginal specula



insulated - for HF Surgery (Radio Frequency), with smoke evacuation



Antireflex - for Laser Surgery (Radio Frequency), with smoke evacuation



Vaginal specula

Cusco


75 mm x 32 mm	DP-786-20-01	DP-786-20-05	DP-786-20-08
85 mm x 35 mm	DP-786-20-02	DP-786-20-06	DP-786-20-09
100 mm x 35 mm	DP-786-20-03	DP-786-20-07	DP-786-20-10

75 mm x 17 mm	DP-786-20-04		
---------------	------------------------------	--	--

for virgins

Cusco


75 mm x 32 mm	DP-786-20-11
85 mm x 35 mm	DP-786-20-12
100 mm x 37 mm	DP-786-20-13

Vaginal specula


Cusco	<input type="checkbox"/>
80 mm x 22 mm	DP-786-20-14
100 mm x 25 mm	DP-786-20-15
105 mm x 27 mm	DP-786-20-16

Swiss pattern


GRAVE	<input type="checkbox"/>	<input checked="" type="checkbox"/>	<input type="checkbox"/>
75 mm x 20 mm	DP-786-20-17	DP-786-20-20	DP-786-20-23
95 mm x 35 mm	DP-786-20-18	DP-786-20-21	DP-786-20-24
115 mm x 35 mm	DP-786-20-19	DP-786-20-22	DP-786-20-25

Vaginal specula

COLLIN

	<input type="checkbox"/>	<input checked="" type="checkbox"/>	<input checked="" type="checkbox"/>
85 mm x 30 mm	DP-786-20-26	DP-786-20-29	DP-786-20-32
100 mm x 35 mm	DP-786-20-27	DP-786-20-30	DP-786-20-33
110 mm x 40 mm	DP-786-20-28	DP-786-20-31	DP-786-20-34


SEMM

	<input type="checkbox"/>
90 mm x 14 / 18 mm	DP-786-20-35
100 mm x 17 / 20 mm	DP-786-20-36
100 mm x 25 / 30 mm	DP-786-20-37


TRELAT

	<input type="checkbox"/>
85 mm x 30 mm	DP-786-20-38
95 mm x 35 mm	DP-786-20-39
115 mm x 43 mm	DP-786-20-40


PEDERSON

	<input type="checkbox"/>
75 mm x 13 mm	DP-786-20-41
100 mm x 22 mm	DP-786-20-42
120 mm x 25 mm	DP-786-20-43

Vaginal specula

KRISTELLER

70 mm x 27 mm	DP-786-20-44
80 mm x 30 mm	DP-786-20-45
90 mm x 36 mm	DP-786-20-46
110 mm x 27 mm	DP-786-20-47
110 mm x 30 mm	DP-786-20-48
110 mm x 36 mm	DP-786-20-49

Speculum

75 mm x 23 mm	DP-786-20-50
85 mm x 26 mm	DP-786-20-51
100 mm x 32 mm	DP-786-20-52
115 mm x 23 mm	DP-786-20-53
115 mm x 26 mm	DP-786-20-54
115 mm x 32 mm	DP-786-20-55

Retractor

DP-786-20-56
DP-786-20-57
DP-786-20-58
DP-786-20-59
DP-786-20-60
DP-786-20-61

Set

Vaginal specula

KRISTELLER

105mm x 18 mm	DP-786-20-62
105 mm x 21 mm	DP-786-20-63

Speculum tapered, for virgins

110 mm x 14 mm	DP-786-20-64
115 mm x 17 mm	DP-786-20-65

Retractor

DP-786-20-66
DP-786-20-67

Set

Vaginal specula

JACKSON

75 mm x 35 mm	DP-786-20-68
75 mm x 40 mm	DP-786-20-69
90 mm x 35 mm	DP-786-20-70
90 mm x 40 mm	DP-786-20-71
100 mm x 35 mm	DP-786-20-72
100 mm x 40 mm	DP-786-20-73


AUVARD

220 mm - 8 3/4"
80 mm x 38 mm
DP-786-20-74


SIMS

60 mm x 25 mm / 30 mm	DP-786-20-75
70 mm x 30 mm / 35 mm	DP-786-20-76
80 mm x 35 mm / 40 mm	DP-786-20-77

Vaginal specula



KALLMORGEN

70 mm x 40 mm	DP-786-20-78
90 mm x 40 mm	DP-786-20-79

Speculum



70 mm x 33 mm	DP-786-20-80
90 mm x 33 mm	DP-786-20-81

Retractor



DP-786-20-82
DP-786-20-83

Set

Vaginal specula

LANDAU

	290 mm - 11½"
100 mm x 28 mm	DP-786-20-84
110 mm x 38 mm	DP-786-20-85

BREISKY

	320 mm - 12¾"
130 mm x 20 mm	DP-786-20-86
130 mm x 25 mm	DP-786-20-87
130 mm x 30 mm	DP-786-20-88
130 mm x 35 mm	DP-786-20-89
130 mm x 40 mm	DP-786-20-90

	300 mm - 12"
100 mm x 20 mm	DP-786-20-91
100 mm x 25 mm	DP-786-20-92
100 mm x 30 mm	DP-786-20-93
100 mm x 35 mm	DP-786-20-94
100 mm x 40 mm	DP-786-20-95

	350 mm - 13¾"
160 mm x 40 mm	DP-786-20-96
180 mm x 40 mm	DP-786-20-97

Vienna pattern

Vaginal specula


Fig. 1	Fig. 2	Fig. 3	Fig. 4	Fig. 5
80 mm x 30 mm	85 mm x 35 mm	90 mm x 40 mm	55 mm x 40 mm / 60 mm	70 mm x 45 mm / 70 mm
DP-786-20-98	DP-786-20-99	DP-786-20-100	DP-786-20-101	DP-786-20-102

SCHERBACK
DP-786-20-103
Set (Fig. 1 - Fig. 2) with weight 400 grs


400 g	DP-786-20-104
600 g	DP-786-20-105
800 g	DP-786-20-106

DP-786-20-107

DOYEN

	240 mm - 9 1/2"
55 mm x 35 mm	DP-786-20-108
85 mm x 35 mm	DP-786-20-109
115 mm x 35 mm	DP-786-20-110
55 mm x 45 mm	DP-786-20-111
85 mm x 45 mm	DP-786-20-112
115 mm x 45 mm	DP-786-20-113
160 mm x 45 mm	DP-786-20-114
55 mm x 60 mm	DP-786-20-115
85 mm x 60 mm	DP-786-20-116
115 mm x 60 mm	DP-786-20-117
160 mm x 60 mm	DP-786-20-118

slightly concave

Endospecula

KOGAN

240 mm - 9½"	DP-786-20-119
--------------	----------------------

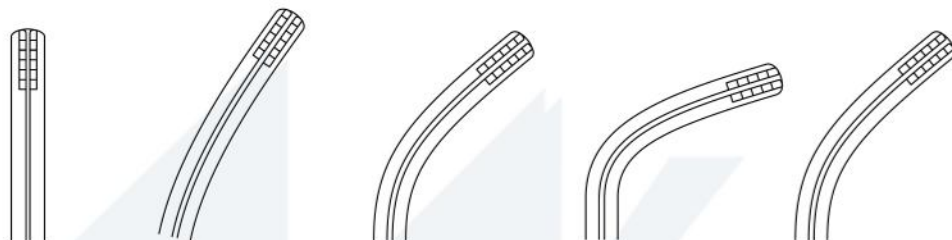
with scale-ratchet and fixation screw


KOGAN-MODIF.

	280 mm - 11"
--	--------------

x = 4 mm	y = 8 mm	DP-786-20-120
----------	----------	----------------------

x = 2 mm	y = 4 mm	DP-786-20-121
----------	----------	----------------------

Parametrium forceps


210 mm - 8 $\frac{1}{4}$ "	DP-786-20-122	DP-786-20-123	DP-786-20-124	DP-786-20-125	DP-786-20-126
240 mm - 9 $\frac{1}{2}$ "	DP-786-20-127	DP-786-20-128	DP-786-20-129	DP-786-20-130	DP-786-20-131
300 mm - 12"	DP-786-20-132	DP-786-20-133	DP-786-20-134	DP-786-20-135	DP-786-20-136
350 mm - 13 $\frac{3}{4}$ "	DP-786-20-137	DP-786-20-138	DP-786-20-139	DP-786-20-140	DP-786-20-141

S-curved

Hysterectomy forceps

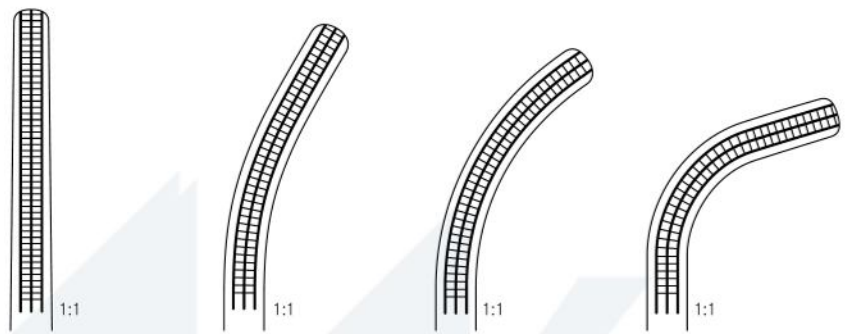
ROGERS


Fig. 1	Fig. 2	Fig. 3	Fig. 4
220 mm - 8 $\frac{3}{4}$ "	215 mm - 8 $\frac{1}{2}$ "	210 mm - 8 $\frac{1}{4}$ "	205 mm - 8"
DP-786-20-142	DP-786-20-143	DP-786-20-144	DP-786-20-145

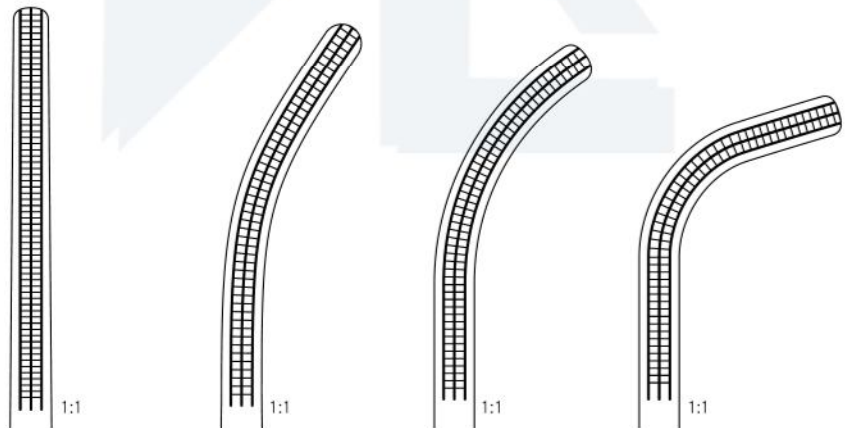


Fig. 1	Fig. 2	Fig. 3	Fig. 4
250 mm - 9 $\frac{3}{4}$ "	250 mm - 9 $\frac{3}{4}$ "	245 mm - 9 $\frac{3}{4}$ "	230 mm - 9"
DP-786-20-146	DP-786-20-147	DP-786-20-148	DP-786-20-149

Uterine sounds



1:2

VALLEIX

250 mm - 9¾" **DP-786-20-150**

graduated, with slider



MARTIN

320 mm - 12½" **DP-786-20-151** **DP-786-20-152**

rigid

malleable



SIMS

320 mm - 12½" **DP-786-20-153** **DP-786-20-154**

rigid

malleable

Uterine dilators


HEGAR

1.0 mm Ø	DP-786-20-155	10.0 mm Ø	DP-786-20-173	20.0 mm Ø	DP-786-20-193
1.5 mm Ø	DP-786-20-156	10.5 mm Ø	DP-786-20-174	21.0 mm Ø	DP-786-20-194
2.0 mm Ø	DP-786-20-157	11.0 mm Ø	DP-786-20-175	22.0 mm Ø	DP-786-20-195
2.5 mm Ø	DP-786-20-158	11.5 mm Ø	DP-786-20-176	23.0 mm Ø	DP-786-20-196
3.0 mm Ø	DP-786-20-159	12.0 mm Ø	DP-786-20-177	24.0 mm Ø	DP-786-20-197
3.5 mm Ø	DP-786-20-160	12.5 mm Ø	DP-786-20-178	25.0 mm Ø	DP-786-20-198
4.0 mm Ø	DP-786-20-161	13.0 mm Ø	DP-786-20-179	26.0 mm Ø	DP-786-20-199
4.5 mm Ø	DP-786-20-162	13.5 mm Ø	DP-786-20-180	27.0 mm Ø	DP-786-20-200
5.0 mm Ø	DP-786-20-163	14.0 mm Ø	DP-786-20-181	28.0 mm Ø	DP-786-20-201
5.5 mm Ø	DP-786-20-164	14.5 mm Ø	DP-786-20-182	29.0 mm Ø	DP-786-20-202
6.0 mm Ø	DP-786-20-165	15.0 mm Ø	DP-786-20-183	30.0 mm Ø	DP-786-20-203
6.5 mm Ø	DP-786-20-166	15.5 mm Ø	DP-786-20-184		
7.0 mm Ø	DP-786-20-167	16.0 mm Ø	DP-786-20-185		
7.5 mm Ø	DP-786-20-168	16.5 mm Ø	DP-786-20-186		
8.0 mm Ø	DP-786-20-169	17.0 mm Ø	DP-786-20-187		
8.5 mm Ø	DP-786-20-170	17.5 mm Ø	DP-786-20-188		
9.0 mm Ø	DP-786-20-171	18.0 mm Ø	DP-786-20-189		
9.5 mm Ø	DP-786-20-172	18.5 mm Ø	DP-786-20-190		
		19.0 mm Ø	DP-786-20-191		
		19.5 mm Ø	DP-786-20-192		

HEGAR

4 mm - 17 mm Ø	14	DP-786-20-204
1 mm - 26 mm Ø	26	DP-786-20-205

Set, without metal case

Uterine dilators


1:3



1:3

HEGAR

4 mm - 17 mm Ø	14	DP-786-20-206	DP-786-20-207
1 mm - 26 mm Ø	26	DP-786-20-208	DP-786-20-209

Pieces per set
Set, in metal case
metal case with 2 shelves

Uterine dilators

HEGAR

1 / 2 mm Ø	DP-786-20-210
3 / 4 mm Ø	DP-786-20-211
5 / 6 mm Ø	DP-786-20-212
7 / 8 mm Ø	DP-786-20-213
9 / 10 mm Ø	DP-786-20-214
11 / 12 mm Ø	DP-786-20-215
13 / 14 mm Ø	DP-786-20-216
15 / 16 mm Ø	DP-786-20-217
17 / 18 mm Ø	DP-786-20-218
19 / 20 mm Ø	DP-786-20-219
21 / 22 mm Ø	DP-786-20-220
23 / 24 mm Ø	DP-786-20-221
25 / 26 mm Ø	DP-786-20-222

HEGAR

3 / 4 mm - 17 / 18 mm Ø	8	DP-786-20-223
1 / 2 mm - 25 / 26 mm Ø	13	DP-786-20-224

Pieces per set Set, only


1:3



1:3

HEGAR

3 / 4 mm - 17 / 18 mm Ø	8	DP-786-20-225	DP-786-20-226
1 / 2 mm - 25 / 26 mm Ø	13		DP-786-20-227

Pieces per set Set in canvas roll
Set, in metal case

Uterine dilators and depressors



HANK		
Fig. 09/10	4.5 / 5.0 mm Ø	DP-786-20-228
Fig. 11/12	5.5 / 6.0 mm Ø	DP-786-20-229
Fig. 13/14	6.5 / 7.0 mm Ø	DP-786-20-230
Fig. 15/16	7.5 / 8.0 mm Ø	DP-786-20-231
Fig. 17/18	8.5 / 9.0 mm Ø	DP-786-20-232
Fig. 19/20	9.5 / 10.0 mm Ø	DP-786-20-233

HANK		
4.5 / 5 mm - 9.5 / 10 mm Ø	6	DP-786-20-234
	<i>Pieces per set</i>	<i>Set, only</i>



1:3

HANK		
4.5 / 5 mm - 9.5 / 10 mm Ø	6	DP-786-20-235
	<i>Pieces per set</i>	<i>Set, in canvas roll</i>



BRAUN
280 mm - 11"
DP-786-20-236

1:3

Tenaculum forceps

1:2

**STAUDE-
MOORE**

170 mm - 6 $\frac{3}{4}$ "

DP-786-20-237

1:2

BARRETT

180 mm - 7"

DP-786-20-238

1:2

SKENE

240 mm - 9 $\frac{1}{2}$ "

DP-786-20-239

1:2

BRAUN

250 mm - 9 $\frac{3}{4}$ "

DP-786-20-240

Tenaculum forceps

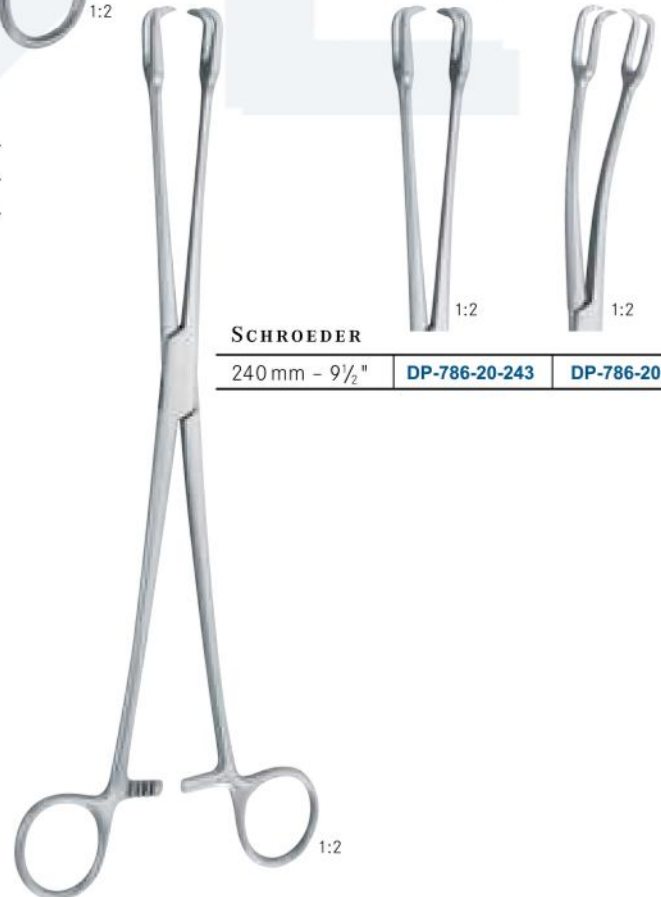
POZZI

255 mm - 10"

DP-786-20-241

SCHROEDER

250 mm - 9¾"

DP-786-20-242

SCHROEDER

240 mm - 9½"

DP-786-20-243
DP-786-20-244

Tenaculum forceps



1:2

DUPLAY

280 mm - 11 "

DP-786-20-245



1:2

IOWA

260 mm - 10 1/4 "

DP-786-20-246



1:2

BEACHAM

260 mm - 10 1/4 "

DP-786-20-247

Amniotome

Tenaculum forceps

MUSEUX

	240 mm - 9 1/2"	240 mm - 9 1/2"
8 mm	DP-786-20-248	DP-786-20-249
6 mm	DP-786-20-250	DP-786-20-251
10 mm	DP-786-20-252	DP-786-20-253


TEALE

230 mm - 9"
DP-786-20-254


JACOBS

210 mm - 8 1/4"	DP-786-20-255	DP-786-20-256
-----------------	----------------------	----------------------

1:2

1:2

Tenaculum forceps



PRATT

260 mm - 10 $\frac{1}{4}$ " **DP-786-20-257**



CZERNY

205 mm - 8" **DP-786-20-258**

Uterine polypus forceps


KELLY

 320 mm - 12½" **DP-786-20-259**

NOTO

 270 mm - 10¾" **DP-786-20-260**

DOYEN

 200 mm - 8" **DP-786-20-261**

Uterine seizing forceps**DARTIGUES**

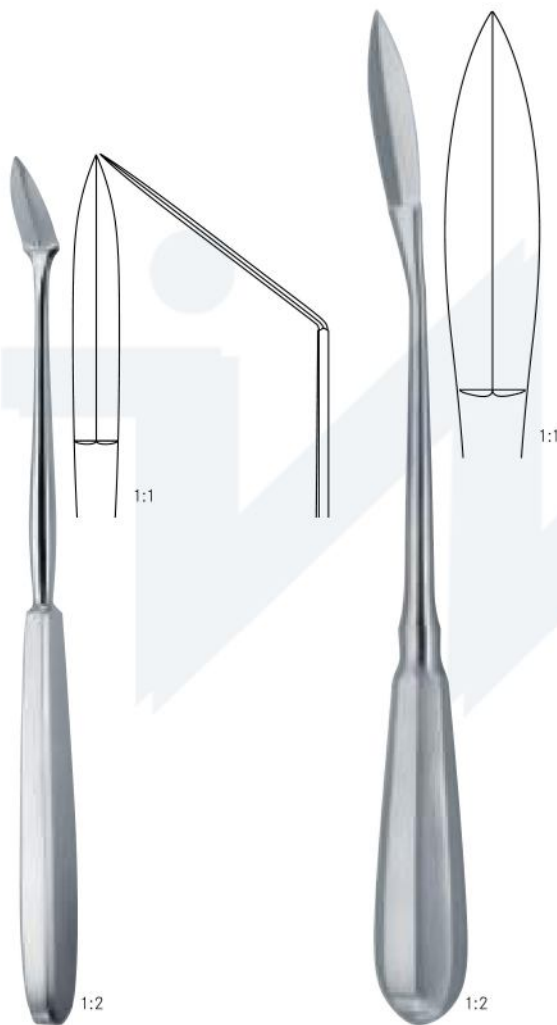
270 mm - 10 $\frac{3}{4}$ "	DP-786-20-262
-----------------------------	----------------------

**SOMER**

230 mm - 9"	DP-786-20-263
-------------	----------------------

**COLLIN**

250 mm - 9 $\frac{3}{4}$ "	DP-786-20-264
----------------------------	----------------------

Myoma instruments**AYRE**

230 mm - 9"

DP-786-20-265**SEGOND**270 mm - 10 $\frac{3}{4}$ "**DP-786-20-266****DOYEN**170 mm - 6 $\frac{3}{4}$ "**DP-786-20-267**

Fistula hooks



SIMON		
	Fig. 1	Fig. 2
220 mm - 8¾"	DP-786-20-268	DP-786-20-269



EMMET		
	Fig. 1	Fig. 2
220 mm - 8¾"	DP-786-20-270	DP-786-20-271
	Fig. 3	Fig. 4
220 mm - 8¾"	DP-786-20-272	DP-786-20-273
	Fig. 5	
220 mm - 8¾"	DP-786-20-274	

Cervical biopsy and specimen forceps



SCHUBERT

210 mm - 8 1/2"	DP-786-20-275
280 mm - 11"	DP-786-20-276



FAURE

210 mm - 8 1/2"	DP-786-20-277
-----------------	----------------------



SCHUBERT

260 mm - 10 1/4"	DP-786-20-278
------------------	----------------------

Cervical biopsy and specimen forceps**GELHORN**

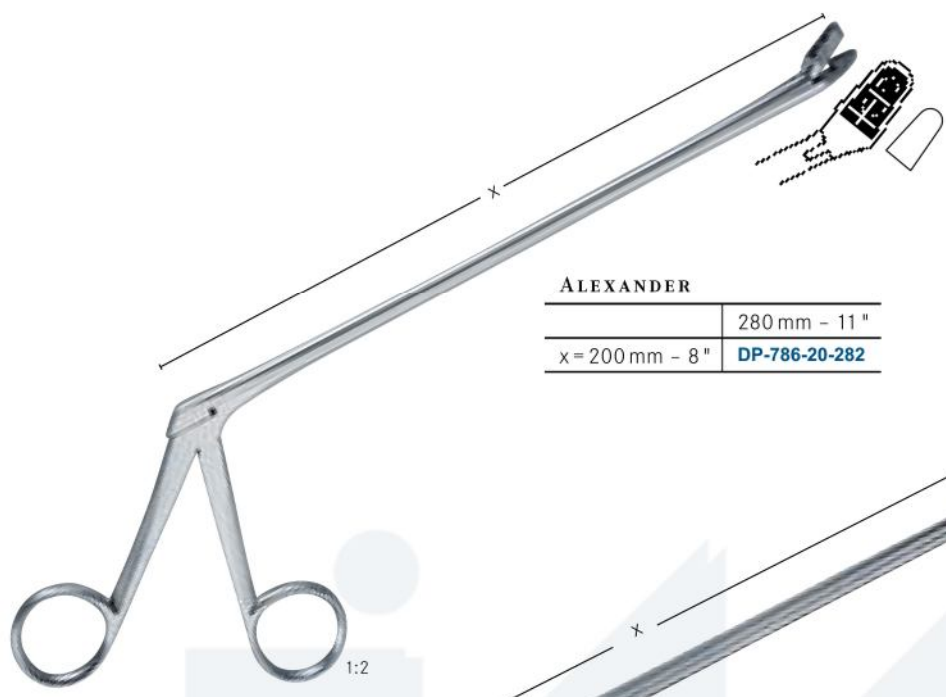
230 mm - 9"	DP-786-20-279
-------------	----------------------

**THOMS-GAYLOR**

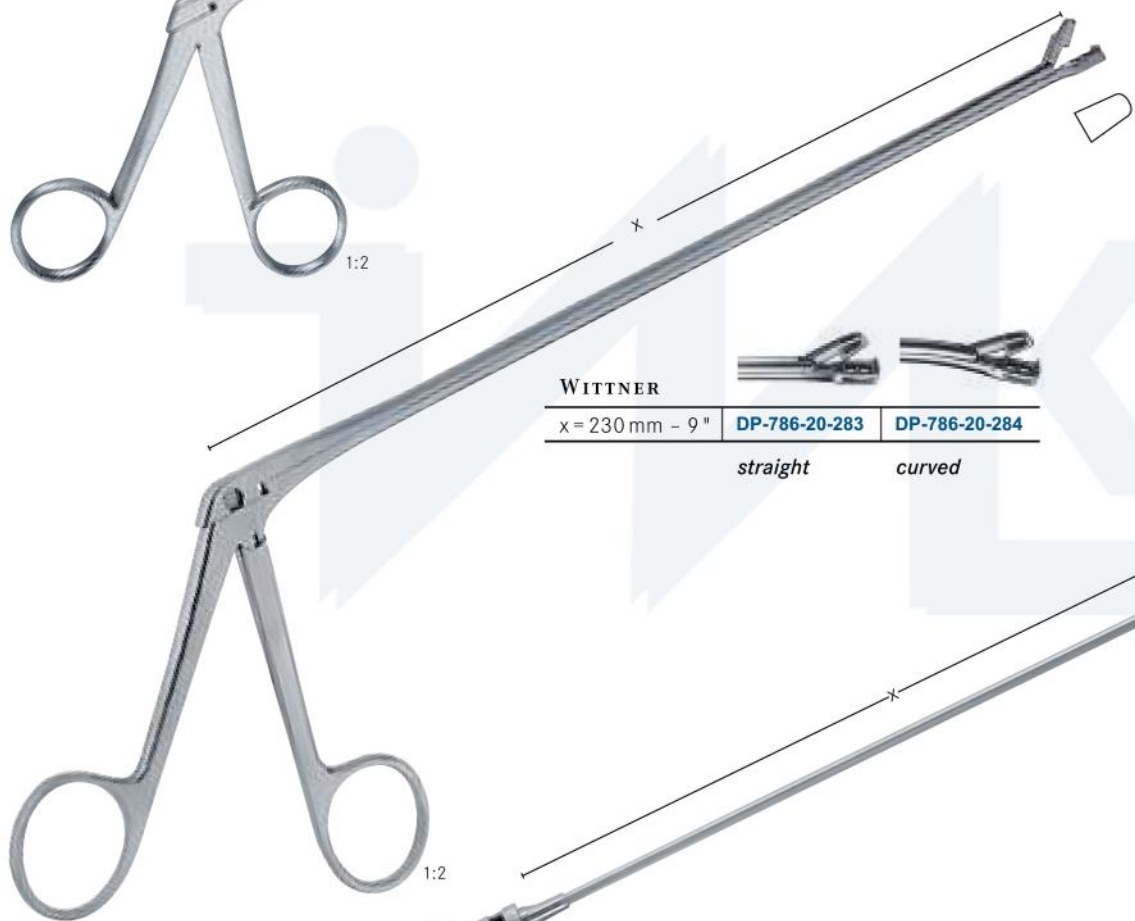
220 mm - 8 $\frac{3}{4}$ "	DP-786-20-280
----------------------------	----------------------

240 mm - 9 $\frac{1}{2}$ "	DP-786-20-281
----------------------------	----------------------

Cervical biopsy and specimen forceps



ALEXANDER	
	280 mm - 11"
x = 200 mm - 8"	DP-786-20-282



WITTNER		
x = 230 mm - 9"	DP-786-20-283	DP-786-20-284
	<i>straight</i>	<i>curved</i>



SCHUMACHER		
x = 230 mm - 9"	DP-786-20-285	DP-786-20-286
	<i>complete</i>	<i>Tip</i>

Cervical biopsy and specimen forceps

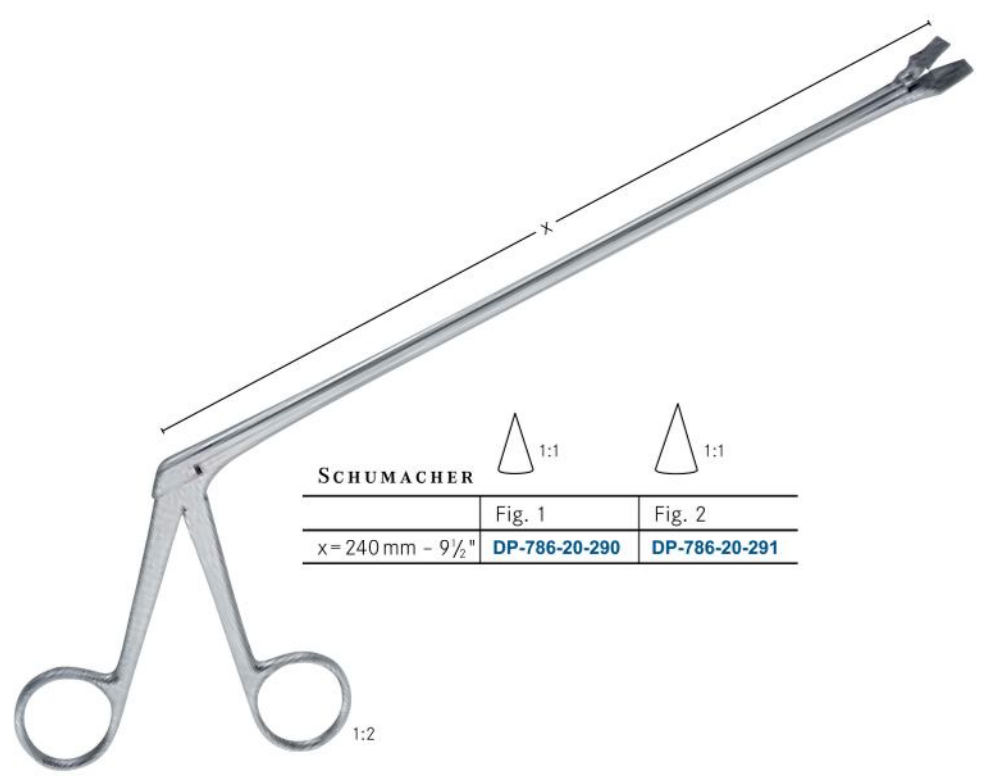


VAN DOREN
240 mm - 9½"
DP-786-20-287



SCHUMACHER

	Fig. 1	Fig. 2
240 mm - 9½"	DP-786-20-288	DP-786-20-289



SCHUMACHER

	Fig. 1	Fig. 2
x = 240 mm - 9½"	DP-786-20-290	DP-786-20-291

Cervical biopsy and specimen forceps

Cervical biopsy and specimen forceps



TISCHLER-MORGAN
USA MODELL

x = 200 mm - 8"	DP-786-20-295
x = 250 mm - 9¾"	DP-786-20-296

TISCHLER-MORGAN

DP-786-20-297
DP-786-20-298

Instrument as illustrated, but without locking screw.

USA MODELL

1:2

Cervical biopsy and specimen forceps



Cervical biopsy and specimen forceps

UNI-TISCHLER

3 x 7 mm

DP-786-20-303
straight, Tip only

DP-786-20-306
Handle only

UNI-TISCHLER

3 x 7 mm

DP-786-20-304
up, Tip only

UNI-TISCHLER

3 x 7 mm

DP-786-20-305
down, Tip only

UNI-TOWNSEND

2.3 x 4 mm

DP-786-20-307
straight, Tip only

UNI-TOWNSEND

2.3 x 4 mm

DP-786-20-308
up, Tip only

UNI-TOWNSEND

2.3 x 4 mm

DP-786-20-309
down, Tip only

UNI-KEVORKIAN

3 x 9 mm

DP-786-20-310
Tip only

DP-786-20-311
Handle only

UNI-OVAL

3 x 5 mm

DP-786-20-312
Tip only

UNI-BURKE

3 x 5 mm

DP-786-20-313
Tip only

Biopsy curettes

RANDALL

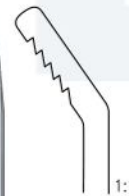
	4 mm Ø
240mm - 9½"	DP-786-20-314


KEVORKIAN

300 mm - 12"	DP-786-20-315	DP-786-20-316
	<i>rigid, without basket</i>	<i>rigid, with basket</i>

DP-786-20-317
DP-786-20-318

malleable, without basket *malleable, with basket*


NOVAK

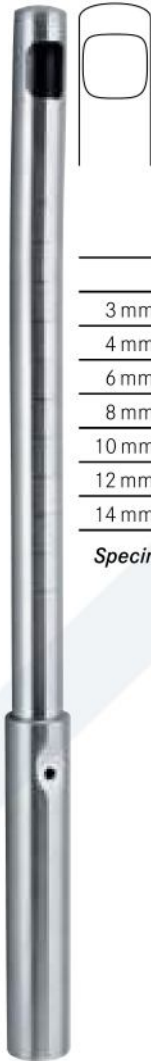
	4 mm Ø
230 mm - 9"	DP-786-20-319

MINI-NOVAK

	235 mm - 9¼"
1 mm Ø	DP-786-20-320
2 mm Ø	DP-786-20-321
3 mm Ø	DP-786-20-322



Aspirating curettes



	200 mm - 11½"
3 mm Ø	DP-786-20-323
4 mm Ø	DP-786-20-324
6 mm Ø	DP-786-20-325
8 mm Ø	DP-786-20-326
10 mm Ø	DP-786-20-327
12 mm Ø	DP-786-20-328
14 mm Ø	DP-786-20-329

Specimen and aspirating curette



120 mm - 4¾"	DP-786-20-330
--------------	----------------------

Coupling piece

1:2

Salpingograph

SCHULTZE

295 mm - 11½"	DP-786-20-331
---------------	----------------------

Salpingograph, complete in wooden case

1:2

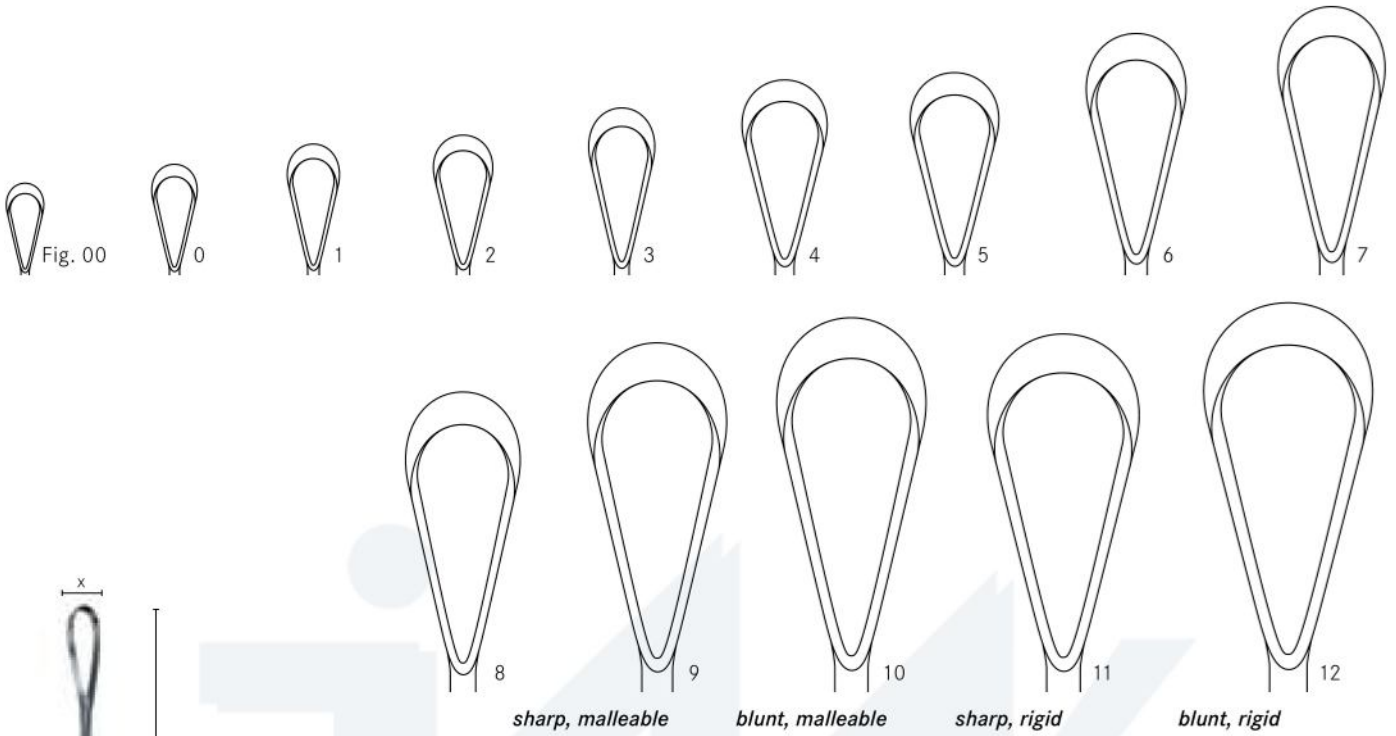


1:2

4 mm Ø	DP-786-20-332
x = 230 mm - 9"	

Forceps for I.U.D. removings

Uterine curettes

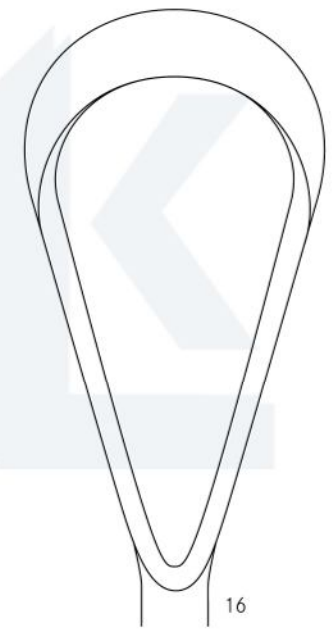
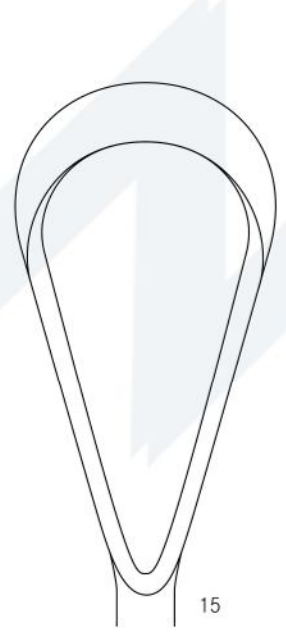
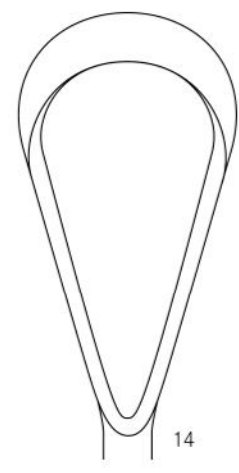
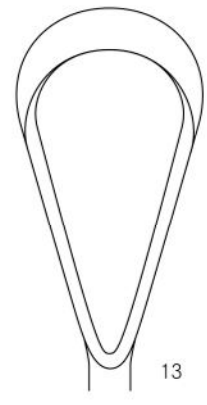


RECAMIER

y=260mm-10¼"						
Fig.	x=mm					
00	5	DP-786-20-333	DP-786-20-347	DP-786-20-361	DP-786-20-375	
0	6	DP-786-20-334	DP-786-20-348	DP-786-20-362	DP-786-20-376	
1	7	DP-786-20-335	DP-786-20-349	DP-786-20-363	DP-786-20-377	
2	8	DP-786-20-336	DP-786-20-350	DP-786-20-364	DP-786-20-378	
3	9	DP-786-20-337	DP-786-20-351	DP-786-20-365	DP-786-20-379	
4	11	DP-786-20-338	DP-786-20-352	DP-786-20-366	DP-786-20-380	
5	12	DP-786-20-339	DP-786-20-353	DP-786-20-367	DP-786-20-381	
6	14	DP-786-20-340	DP-786-20-354	DP-786-20-368	DP-786-20-382	
7	15	DP-786-20-341	DP-786-20-355	DP-786-20-369	DP-786-20-383	
8	16	DP-786-20-342	DP-786-20-356	DP-786-20-370	DP-786-20-384	
9	19	DP-786-20-343	DP-786-20-357	DP-786-20-371	DP-786-20-385	
10	20	DP-786-20-344	DP-786-20-358	DP-786-20-372	DP-786-20-386	
11	21	DP-786-20-345	DP-786-20-359	DP-786-20-373	DP-786-20-387	
12	23	DP-786-20-346	DP-786-20-360	DP-786-20-374	DP-786-20-388	

y=310mm-12¼"						
Fig.	mm					
00	5	DP-786-20-389	DP-786-20-403	DP-786-20-417	DP-786-20-431	
0	6	DP-786-20-390	DP-786-20-404	DP-786-20-418	DP-786-20-432	
1	7	DP-786-20-391	DP-786-20-405	DP-786-20-419	DP-786-20-433	
2	8	DP-786-20-392	DP-786-20-406	DP-786-20-420	DP-786-20-434	
3	9	DP-786-20-393	DP-786-20-407	DP-786-20-421	DP-786-20-435	
4	11	DP-786-20-394	DP-786-20-408	DP-786-20-422	DP-786-20-436	
5	12	DP-786-20-395	DP-786-20-409	DP-786-20-423	DP-786-20-437	
6	14	DP-786-20-396	DP-786-20-410	DP-786-20-424	DP-786-20-438	
7	15	DP-786-20-397	DP-786-20-411	DP-786-20-425	DP-786-20-439	
8	16	DP-786-20-398	DP-786-20-412	DP-786-20-426	DP-786-20-440	
9	19	DP-786-20-399	DP-786-20-413	DP-786-20-427	DP-786-20-441	
10	20	DP-786-20-400	DP-786-20-414	DP-786-20-428	DP-786-20-442	
11	21	DP-786-20-401	DP-786-20-415	DP-786-20-429	DP-786-20-443	
12	23	DP-786-20-402	DP-786-20-416	DP-786-20-430	DP-786-20-444	

Uterine curettes



sharp, malleable

blunt, malleable

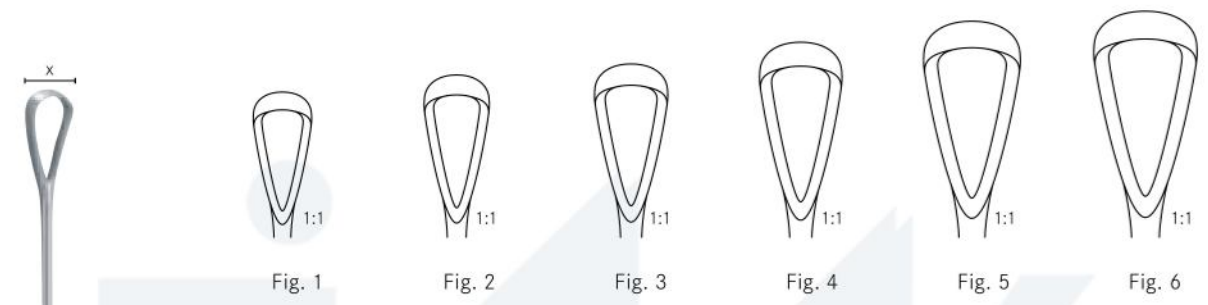
sharp, rigid

blunt, rigid

RECAMIER

y=340mm-13½"	Fig.	x=mm				
	13	25	DP-786-20-445	DP-786-20-449	DP-786-20-453	DP-786-20-457
	14	30	DP-786-20-446	DP-786-20-450	DP-786-20-454	DP-786-20-458
	15	35	DP-786-20-447	DP-786-20-451	DP-786-20-455	DP-786-20-459
	16	40	DP-786-20-448	DP-786-20-452	DP-786-20-456	DP-786-20-460

Uterine curettes






SIMS

250 mm - 9 3/4"	Fig.	x=mm				
	1	7	DP-786-20-461	DP-786-20-467	DP-786-20-473	DP-786-20-479
	2	8	DP-786-20-462	DP-786-20-468	DP-786-20-474	DP-786-20-480
	3	9	DP-786-20-463	DP-786-20-469	DP-786-20-475	DP-786-20-481
	4	11	DP-786-20-464	DP-786-20-470	DP-786-20-476	DP-786-20-482
	5	12	DP-786-20-465	DP-786-20-471	DP-786-20-477	DP-786-20-483
	6	14	DP-786-20-466	DP-786-20-472	DP-786-20-478	DP-786-20-484




sharp, malleable
blunt, malleable
sharp, rigid
blunt, rigid

Uterine spoons

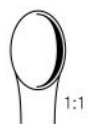







SIMON	 1:1	 1:1	 1:1
	Fig. 1	Fig. 2	Fig. 3
250 mm - 9 3/4"	DP-786-20-485	DP-786-20-486	DP-786-20-487

sharp, rigid

 1:1	 1:1	 1:1
Fig. 4	Fig. 5	Fig. 6
DP-786-20-488	DP-786-20-489	DP-786-20-490



SCHRÖDER	 1:1	 1:1	 1:1
	Fig. 1	Fig. 2	Fig. 3
300 mm - 12"	DP-786-20-491	DP-786-20-492	DP-786-20-493

 1:1	 1:1	 1:1
Fig. 4	Fig. 5	Fig. 6
DP-786-20-494	DP-786-20-495	DP-786-20-496

Obstetrical forceps



1:3

SIMPSON

300 mm - 12"	DP-786-20-497
--------------	----------------------


**SIMPSON-
BRAUN**

330 mm - 13"	DP-786-20-498
360 mm - 14¼"	DP-786-20-499


NAEGELE

360 mm - 14¼"	DP-786-20-500
400 mm - 16"	DP-786-20-501



1:3

PIPER

440 mm - 17¼"	DP-786-20-502
---------------	----------------------

Obstetrical forceps


SIMPSON-LUIKART 1:3
 360 mm - 14¼" **DP-786-20-503**



WRIGLEY 1:3
 230 mm - 9" **DP-786-20-504**
for caesarian section



DELEE 1:3
 300 mm - 12" **DP-786-20-505**



DELEE
 360 mm - 14¼" **DP-786-20-506**
 390 mm - 15½" **DP-786-20-507**

Obstetrical forceps

ELLIOT

320 mm - 12½"	DP-786-20-508
380 mm - 15"	DP-786-20-509


MCLEAN

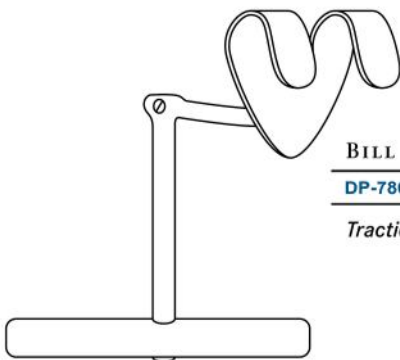
360 mm - 14¼"	DP-786-20-510
---------------	----------------------


KIELLAND

410 mm - 16¼"	DP-786-20-511
---------------	----------------------


KIELLAND-LUKART

400 mm - 16"	DP-786-20-512
--------------	----------------------


BILL
DP-786-20-513
Traction handle for all the forceps with horned standard handle

Obstetrics

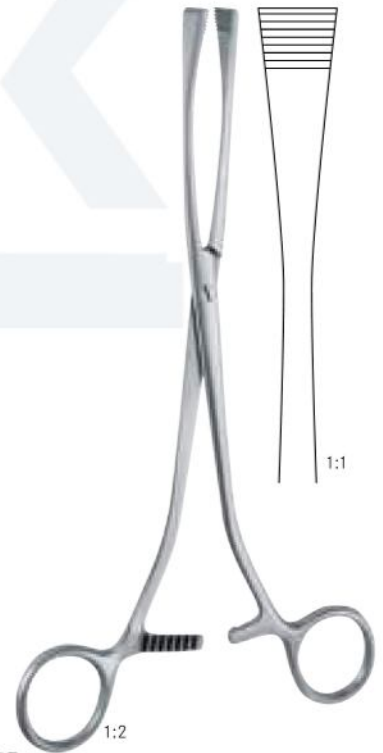

1:2

SELLHEIM

 280 mm - 11" | **DP-786-20-514**
Obstetric lever


1:2

BRAUN

 325 mm - 12³/₄" | **DP-786-20-515**
Decapitating hook


1:1

1:2

**GREEN-
ARMYTAGE**

 210 mm - 8¹/₄" | **DP-786-20-516**
Uterine elevating forceps

Obstetrics


SMELLIE

 250 mm - 10" **DP-786-20-517**
Perforator

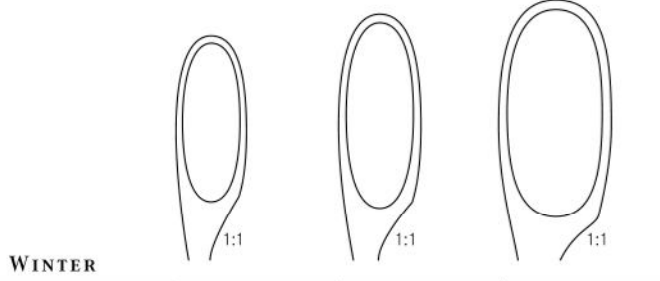
BRAUN

 420 mm - 16½" **DP-786-20-518**
Cranioclast, one jaw fenestrated

TARNIER

 460 mm - 17¼" **DP-786-20-519**
Basiotribe

Abortion forceps - Ovum curettes

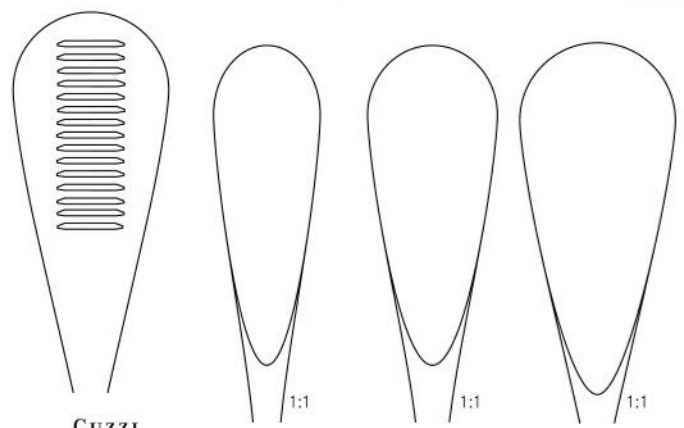


WINTER			
	Fig. 1	Fig. 2	Fig. 3
280 mm - 11 "	DP-786-20-520	DP-786-20-521	DP-786-20-522

straight

DP-786-20-523	DP-786-20-524	DP-786-20-525
---------------	---------------	---------------

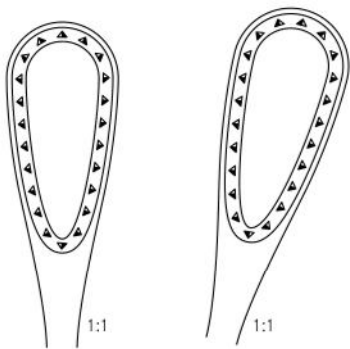
curved



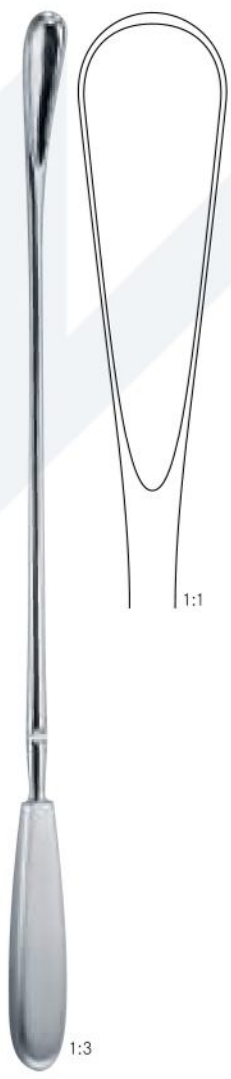
CUZZI			
	14.5 mm	18.0 mm	21.0 mm
300 mm - 12 "	DP-786-20-526	DP-786-20-527	DP-786-20-528

blunt, back serrated

Abortion forceps - Ovum curettes



SAENGER
 270 mm - 10³/₄" **DP-786-20-529** **DP-786-20-530**



1:3

WALLICH
 420 mm - 16¹/₂" **DP-786-20-531**

blunt



1:3

PESTALOZZA
 300 mm - 12" **DP-786-20-532**

Umbilical cord clamps

Pelvimeters

